

Dimensões em polegada
Dimensions in inches

THIS IS AN UPDATED REVISION, THE
PREVIOUS ONE MUST BE DISREGARDED.

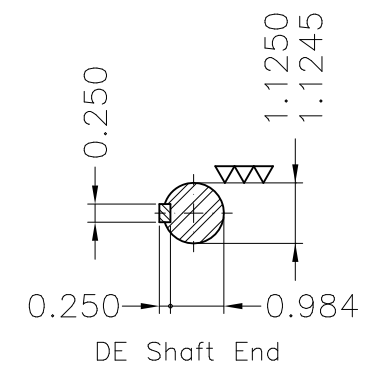
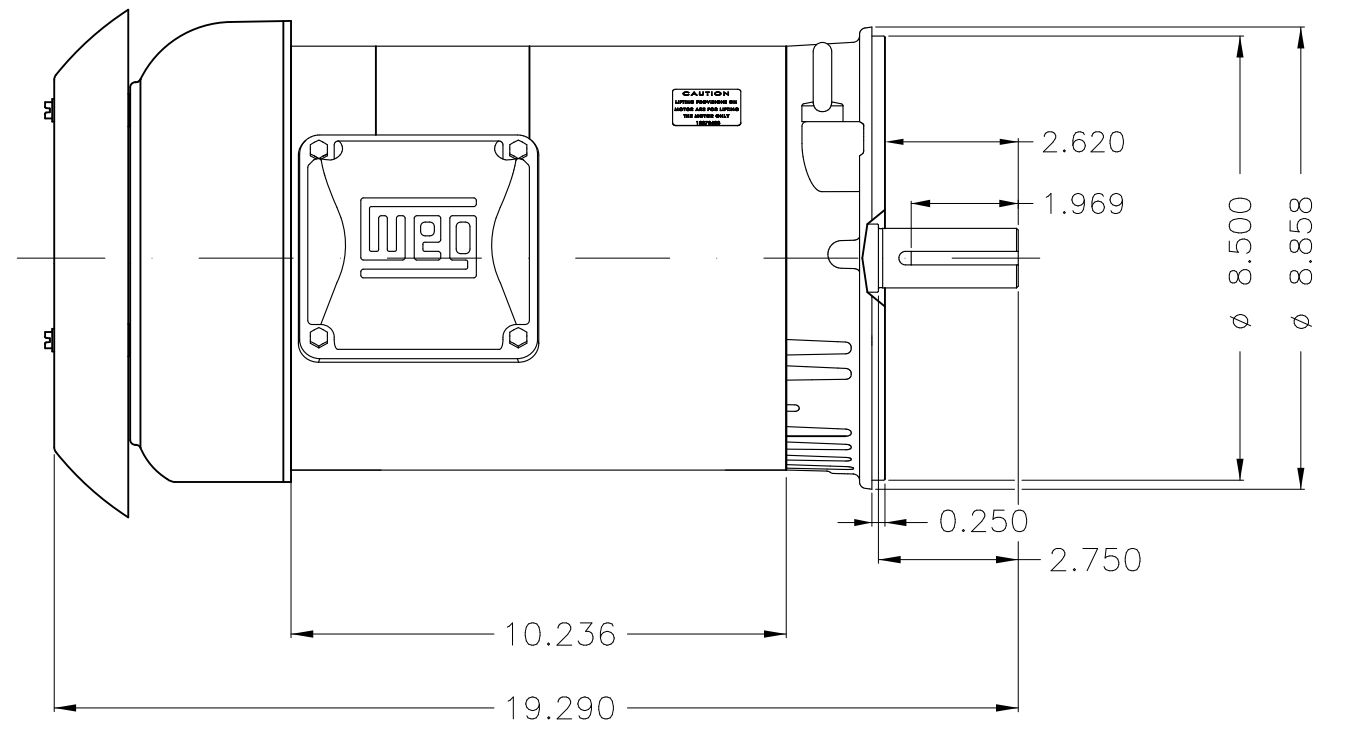
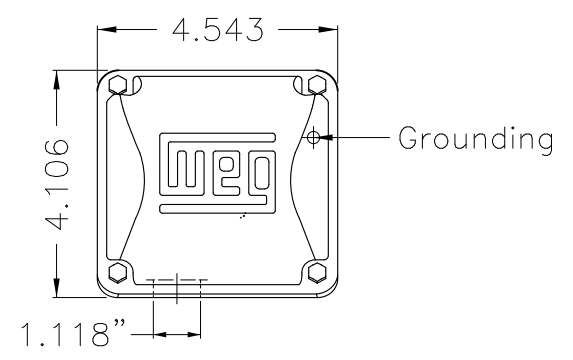
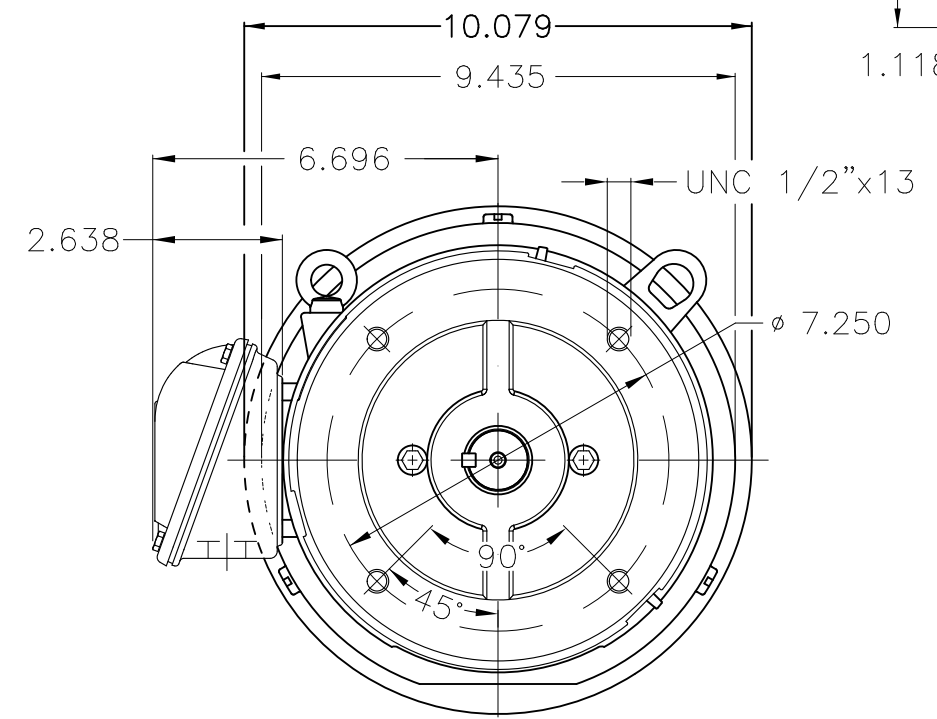

Color Munsell N 1 matte black
Painting plan 207N
Mounting W-6/V18R(D)

ECM	LOC	SUMMARY OF MODIFICATIONS	EXECUTED	CHECKED	RELEASED	DATE	VER
EXECUTED	USERADMIN	THREE P. MOTOR CLOS ROLLED STEEL NEMA PREM					
CHECKED		FRAME 182/4TC IP55 TEFC					
RELEASED		WEG code: 12677335					
REL DT	21.08.2020	WMO Jaragua do Sul	Product Engineering	SHEET	1 / 1		

5 HP 04 Poles 60Hz

A

